

Specifications and Operation Manual for DS-980

Prepared : 16 January 2003
1st Amendment : 14 August 2003

1. General Layout	4
2. Purpose	5
3. Features.....	5
4. Operating Conditions.....	5
5. Analog Specification	5
6. Capacity/Minimum Graduation/Tare range	5
7. Display and Indicators	5
7.1. Display Specifications.....	6
7.2. Indicators.....	6
8. Dimensions	6
9. Connectors on the Main Board.....	6
10. Main Components.....	6
11. Existing parts to be used.....	6
12. Key Functions	6
13. Block Diagram of Electrical Connection	7
14. Physical layout of Electrical Connection	8
15. Hardware Description.....	9
15.1. Microcomputer	9
15.2. Pin Assignment.....	9
16. Maintenance Mode	11
16.1. SPAN Adjustment.....	11
16.2. Escape from Maintenance mode	11
16.3. Specification Setting.....	11
16.3.1. Operational Spec Enter.....	11
16.3.2. Weight & Measure Spec Enter	12
16.4. Internal Count & A/D Count Display.....	12
16.5. Software ID code & Span Switch State check	12
16.6. Key function in Maintenance Mode.....	12
16.5. Spec List.....	13
16.5.1. Operational Spec List	13
16.5.2. Weight & Measure Spec List.....	14
17. Operations In Weighing Mode	16
17.1. ON/OFF.....	16
17.2. Weight Reset	16
17.3. Tare Subtraction	16
18. Error Massage List.....	16
19. RS-232C Interface	17
19.1. Specification.....	17
19.2. Pin Assignment.....	17
19.3. Control Code and Characters	17
19.4. Standard type.....	18
19.4.1. Data Format	18
19.4.2. Communication Method.....	19
19.4.2.1. Standard stream type(Continuous Output).....	20
19.4.2.2. Standard command type.....	20
19.5. QUQA TRADING type.....	21
19.6. IBM, HUGIN type.....	23
19.7. ICL type.....	24
19.7.1. ICL (OLD, OLD OMRON) type	25
19.7.2. ICL (PORTUGAL) type.....	26
19.7.3. ICL (ACTUAL, ACTUAL OMRON) type.....	27

19.8. CAS interface type	28
19.9. CAS (PORTUGAL) type	31
19.10. NIXDORF type	32
19.11. NCR type	34
19.12. MONS type.....	35
19.13. SHARP TK300, UP700 type.....	37
19.14. DATECS MP50/500 type.....	40
19.15. NCI4000 type	41

1. General Layout

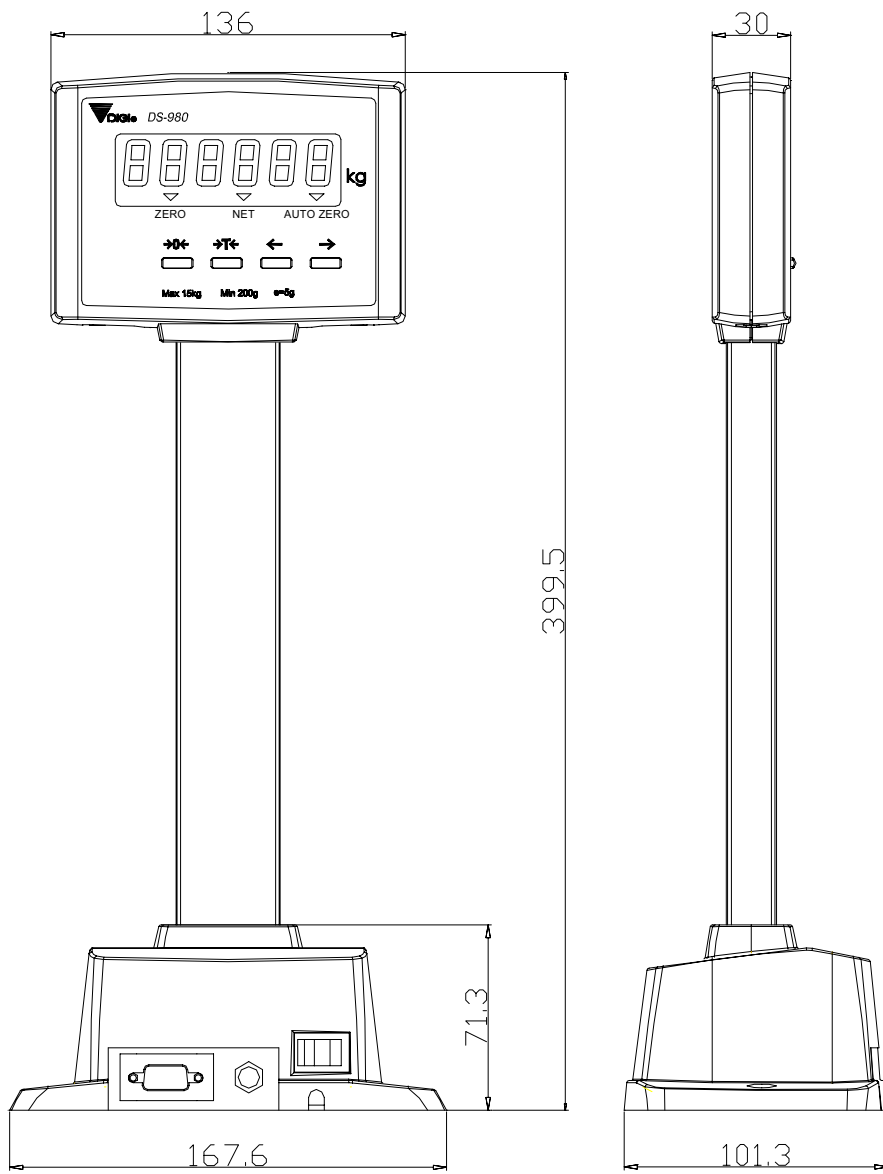

2. Purpose

To develop an LCD display check out scale.

3. Features

- * Quick response to weight changes.
- * Capacity : 15kg, 30kg.
- * Resolution : Display Resolution 1/3000.
: Internal Resolution 1/90000.
- * Calibration by software.
- * Customer and operator displays.
- * 4 keys for operation and maintenance.
- * Multitudinous ECR/POS protocol.
- * Compact size.
- * Low power consumption.

4. Operating Conditions

- * Power Source : DC 12V.
- * Operating Temperature : -10°C ~ +40°C.
- * Operating Humidity : 15 ~ 85% RH.
- * Power Consumption : 1W.

5. Analog Specification

- * Input sensitivity : 1mV/V.
- * Zero adjust range : $0 \pm 5\text{mV}$.
- * Zero balance range : $0 \pm 0.5\text{mV}$.
- * L/C applied voltage : DC 5V.
- * Speed of A/D conversion : 8 times/sec.
- * Internal Resolution : 90000.

6. Capacity/Minimum Graduation/Tare range

Capacity	Minimum Graduation	Tare Rang
15kg	5g (1e = 30IR)	0 - 7.495kg
30kg	10g (1e = 30IR)	0 - 14.99kg

*NOTE : IR -> Internal Resolution, e -> Division(Minimum Increment).
Internal count(full capacity) = 90000IR.

7. Display and Indicators

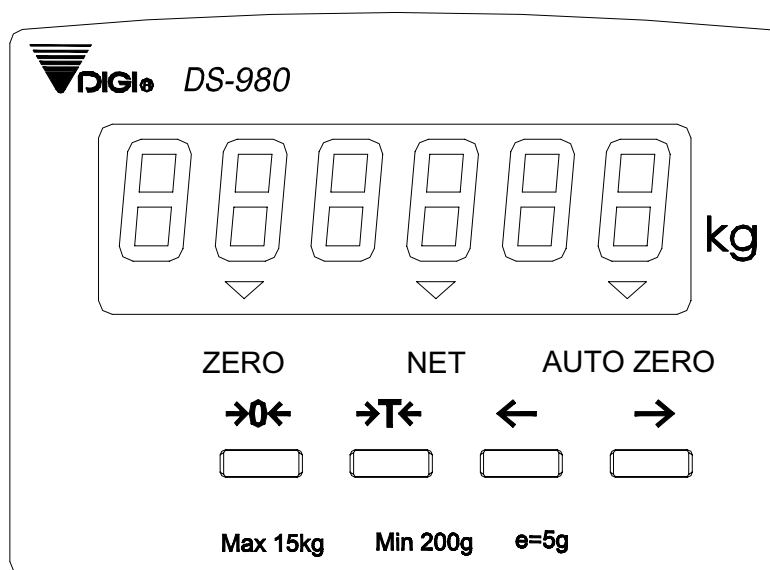

7.1. Display Specifications

* Weight Display : 6 digits.

7.2. Indicators

- *  : On when zero point is adjusted and weight is stable.
- * NET : On when tare subtraction is performed.
- * AUTO ZERO : On when Auto Zero function (for Japan only) is in effect.

8. Dimensions

- * Overall size: : 167.6(W) x 101.3(D) x 399.5(H) mm.
- * Display unit size : 136(W) x 30(D) x 104(H) mm.

9. External Connectors

- * DC receptacle.
- * RS-232C connector.
- * Loadcell connector.





10. Main Components

- * Microcomputer : Hitachi HD6473644(8 Bit, 32K PROM) / HD6433644(8 Bit, 32K ROM) / HD6433643(8 Bit, 24K ROM) / HD6433642(8 Bit, 16K ROM) .
- * Crystal Oscillator : 10 MHz.
- * Display device : LCD.

11. Existing parts to be used

- * LCD (DS-860).

12. Key Functions

-  : RE-ZERO key. Resets weight display to zero.
-  : TARE key. Set or clears tare value.
-  : To set "1" in Maintenance mode.
-  : To set "0" in Maintenance mode.

13. Block Diagram of Electrical Connection

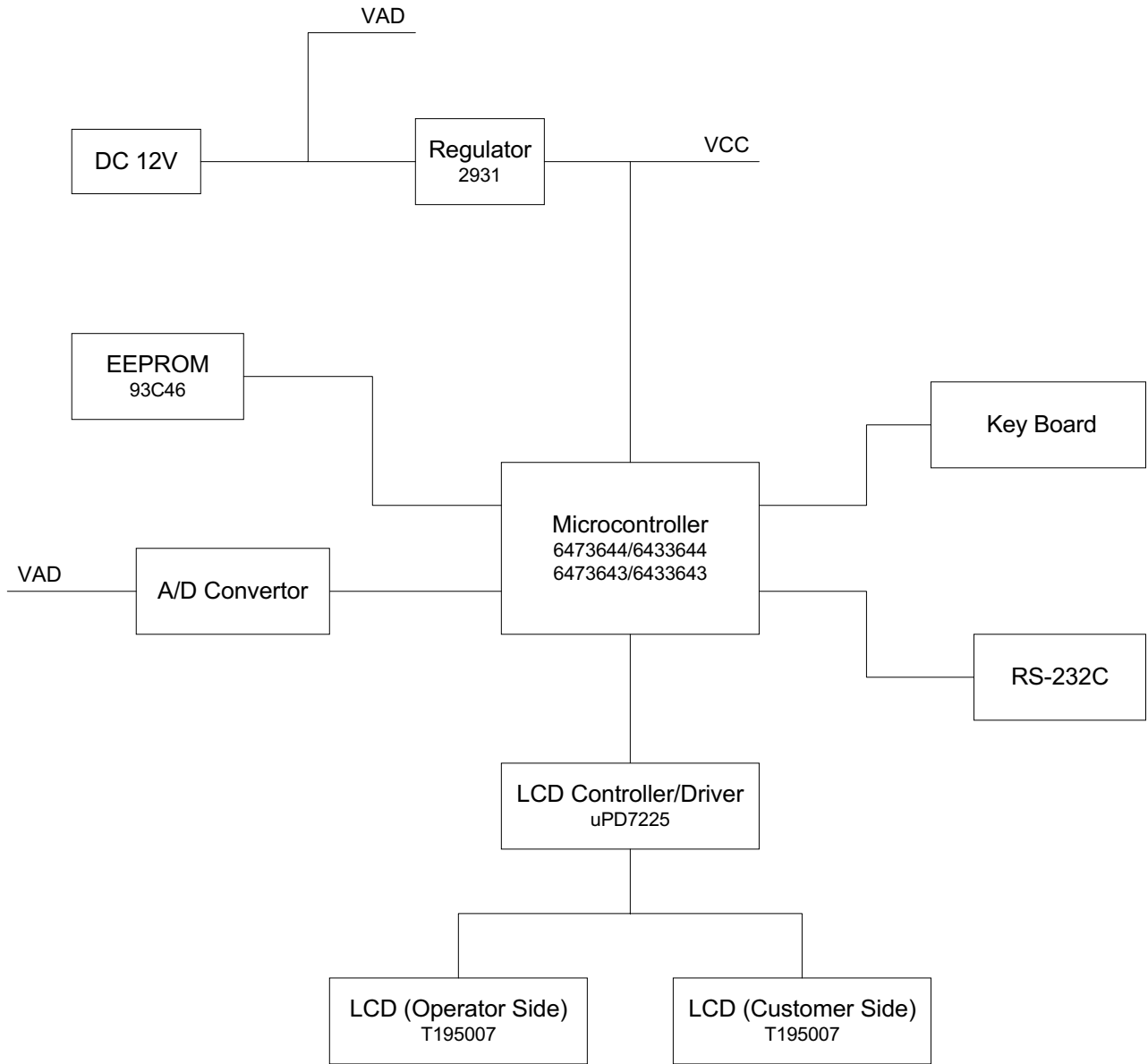

14. Physical layout of Electrical Connection

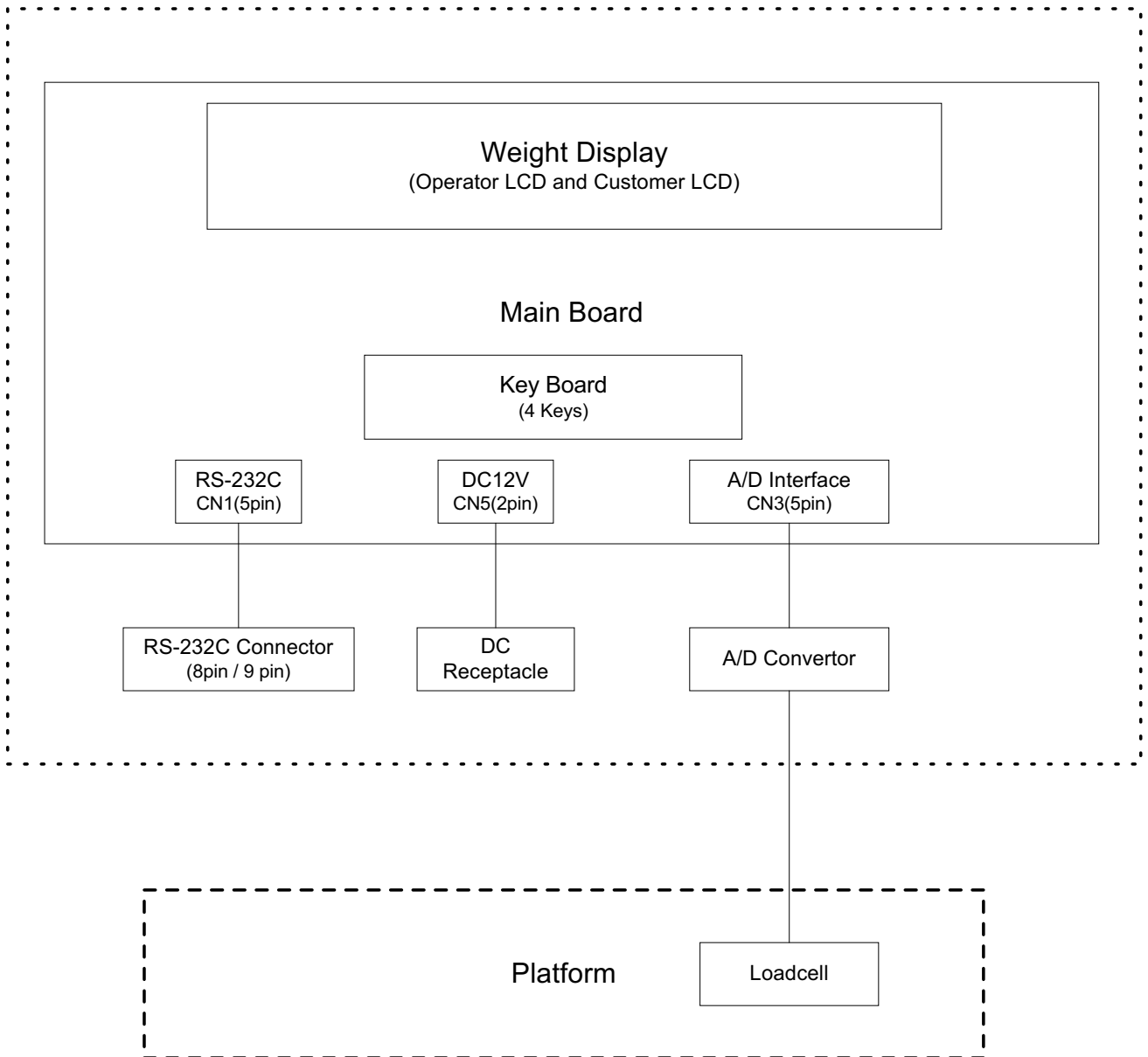

15. Hardware Description

15.1. Microcomputer

The HD6473644/ HD6433644/ HD6433643/ HD6433642 Microcomputer was chosen for the following reasons:

- * Cheaper.
- * High-speed CPU with sixteen 8-bit registers.
- * Having an on-chip programmable FIP controller/driver.
- * 33 interrupt sources and efficient interrupt processing.
- * Five versatile timers.
- * Two on-chip serial communication interface channels and 8-channel A/D converter.
- * Less chip count.
- * Pin compatibility of similar package with difference ROM sizes.
- * Good support.

15.2. Pin Assignment

Pin	I/O	Assignment	Device	Remark
P10/TMOW	O	CS	93LC46	EEPROM
P14/PWM	O	SK	93LC46	EEPROM
P15/IRQ1	I	DI	93LC46	EEPROM
P16/IRQ2	O	DO	93LC46	EEPROM
P17/IRQ3/TRGV	I	CCTS	MAX232	RS-232C
P20/SCK3	O	CRTS	MAX232	RS-232C
P21/RXD	I	CRXD	MAX232	RS-232C
P22/TXD	O	CTXD	MAX232	RS-232C
P30/SCK1				
P31/SI1				
P32/SO1				
P50/INT0	I	KREZERO	Keyboard	Key Detection Line
P51/INT1	I	KTARE	Keyboard	Key Detection Line
P52/INT2	I	KLARROW	Keyboard	Key Detection Line
P53/INT3	I	KUPARROW	Keyboard	Key Detection Line
P54/INT4				
P55/INT5/ADTRG				
P56/INT6/TMIB				
P57/INT7				
P60				
P61				
P62				
P63				
P64				
P65				
P66				
P67				
P73	O	CCS	UPD7225	LCD Controller/Driver
P74/TMRIV	O	CCD	UPD7225	LCD Controller/Driver
P75/TMCIV	O	CSCK	UPD7225	LCD Controller/Driver
P76/TMOV	O	CSI	UPD7225	LCD Controller/Driver
P77				

Pin	I/O	Assignment	Device	Remark
P80/FTCI				
P81/FTOA	O	ADS1	4051	Controls A/D Conversion
P82/FTOB	O	ADS2	4051	Controls A/D Conversion
P83/FTIA	I	ADINT	LMC6032	A/D Conversion Interrupt
P84/FTIB				
P85/FTIC				
P86/FTID				
P87				
P90/FVPP				
P91				
P92				
P93				
P94				
PB0/AN0				
PB1/AN1				
PB2/AN2				
PB3/AN3				
PB4/AN4				
PB5/AN5				
PB6/AN6				
PB7/AN7				
IRQ0				
OSC1	I	-	Oscillator	10 MHz Crystal
OSC2	O	-	Oscillator	10 MHz Crystal
X1	I	-	-	Connected to VCC Pin
X2	O	-	-	-
AVCC	-	-	-	Analog power supply
AVSS	-	-	-	Analog ground
VCC	-	-	-	Power supply
VSS	-	-	-	Ground
TEST	I	-	-	-
RES	I	-	Reset device	System Reset

16. Maintenance Mode

16.1. SPAN Adjustment

1 - NET 2 - ZERO 3 - AUTO ZERO

OPERATION	WEIGHT	1	2	3	REMARKS
	0.000		▼		Weighing mode.
[RE-ZERO]	888888				Enter [⇐] [TARE] [TARE] while pressing
[RE-ZERO] + [⇐] [TARE] [TARE]	CAL00				RE-ZERO.
Ensure no weight on platter, [RE-ZERO]	- - - -				Calibrating zero point.
:	-				
:					
:					
Put full capacity weight on platter	CALSP				
(e.g. 15kg), [RE-ZERO]	- - - -				Calibrating Span.
	-				
After calibration	15.000				Goes back to Weighing mode.

16.2. Escape from Maintenance mode

1 - NET 2 - ZERO 3 - AUTO ZERO

OPERATION	WEIGHT	1	2	3	REMARKS
[RE-ZERO]	888888				Enter [⇐] [TARE] [TARE] while pressing
[RE-ZERO] + [⇐] [TARE] [TARE]	CAL00				RE-ZERO.
[TARE]	0.000		▼		Escape to Weighing mode.
[RE-ZERO]	888888				Enter [⇐] [TARE] [TARE] while pressing
[RE-ZERO] + [⇐] [TARE] [TARE]	CAL00				RE-ZERO.
Ensure no weight on platter, [RE-ZERO]	- - - -				Calibrating zero point.
:	-				
:					
	CALSP				
[TARE]	0.000		▼		Escape to Weighing mode.

16.3. Specification Setting

16.3.1. Operational Spec Enter

1 - NET 2 - ZERO 3 - AUTO ZERO

OPERATION	WEIGHT	1	2	3	REMARKS
[RE-ZERO]	888888				Enter [⇐] [⇐] [⇐] while depressing
[RE-ZERO] + [⇐] [⇐] [⇐]	S P C 00				RE-ZERO. Display shows SPEC number
	0001				and setting value alternately
[⇐]	0010				To set 0.
[⇑]	0101				To set 1.
[RE-ZERO]	S P C 01				To save data and increase SPEC count.
	0000				
[TARE]	0.000		▼		Go back to Weighing mode.

16.3.2. Weight & Measure Spec Enter

1 - NET 2 - ZERO 3 - AUTO ZERO

OPERATION	WEIGHT	1	2	3	REMARKS
[RE-ZERO]	8 8 8 8 8 8				Enter [⇐] [TARE] [⇐] while depressing
[RE-ZERO] + [⇐] [TARE] [⇐]	S P C 1 2				RE-ZERO. Display shows SPEC number
	0 0 0 0				and setting value alternately
[⇐]	0 0 0 0				To set 0.
[↑]	0 0 0 1				To set 1.
[RE-ZERO]	S P C 1 3				To save data and increase SPEC count.
	0 0 0 0				
[TARE]	0.0 0 0		▼		Go back to Weighting mode.

16.4. Internal Count & A/D Count Display

1 - NET 2 - ZERO 3 - AUTO ZERO

OPERATION	WEIGHT	1	2	3	REMARKS
[RE-ZERO]	8 8 8 8 8 8				Enter [⇐] [⇐] [TARE] while depressing
[RE-ZERO] + [⇐] [⇐] [TARE]	0				RE-ZERO. Display Internal Count.
[↑]	1 5 0 0 0				Change to A/D Count.
[↑]	0				Change to Internal Count.
Put weight on the platter.	8 6 6				
[RE-ZERO]	0				RE-ZERO operation.
[TARE]	0.0 0 0		▼		Go back to Weighing mode.

16.5. Software ID code & Span Switch State check

1 - NET 2 - ZERO 3 - AUTO ZERO

OPERATION	WEIGHT	1	2	3	REMARKS
[RE-ZERO]	8 8 8 8 8 8				Enter [TARE] [⇐] [⇐] while depressing
[RE-ZERO] + [TARE] [⇐] [⇐]	S T E 1 5				RE-ZERO. Display software ID for 1s.
	S - O N				Display current Span Switch state: (S-ON or S-OFF)
	0.0 0 0		▼		Exit after 3s.

16.6. Key function in Maintenance Mode

Key Function	RE-ZERO	TARE	⇐	↑
SPAN Adjustment [⇐] [TARE] [TARE]	To confirm calibration.	To exit.	-	-
Operational Spec Enter [RE-ZERO] + [⇐] [⇐] [⇐]	To save data and increase SPEC count.	To exit.	To set "0".	To set "1".
Weight & Measure Spec Enter [RE-ZERO] + [⇐] [TARE] [⇐]	To save data and increase SPEC count.	To exit.	To set "0".	To set "1".
Internal Count & A/D Count Display [⇐] [⇐] [TARE]	To reset weight.	To exit.	-	To alter mode.
Software ID code & Span Switch State check [TARE] [⇐] [⇐]	-	-	-	-

16.5. Spec List

16.5.1. Operational Spec List

SPEC NO.	BIT 3	BIT 2	BIT 1	BIT 0
0	RTS/CTS handshaking of RS-232C 0 - On 1 - Off	Baud rate of RS-232C 000 - 1200 bps 001 - 2400 bps 010 - 4800 bps 011 - 9600 bps 100 - 19200 bps 101 - Not used 110 - Not used 111 - Not used		
1	Stop bit of RS-232C 0 - 1 bit 1 - 2 bit	Data length of RS-232C 0 - 7 bit 1 - 8 bit	Parity of RS-232C 00 - None 01 - Odd 10 - Even 11 - Not used	
2	Data transfer protocol of RS-232C 00000 - Inhibit data transfer 00001 - Standard stream type (Continuous output) 00010 - Standard command type 00011 - QUQA TRADING type 00100 - IBM, HUGIN type 00101 - ICL (OLD, OLD OMRON) type 00110 - ICL (PORTUAGAL) type 00111 - ICL (ACTUAL, ACTUAL OMRON) type 01000 - CAS type 01001 - CAS (PORTUAGAL) type 01010 - NIXDORF type 01011 - NCR type 01100 - MONS type 01101 - SHARP TK300, UP700 type 01110 - DATECS MP50/500 type 01111 - NCI4000 type 10000 ~ 11111 - Not used			
3				Data transfer mode of RS-232C BIT4 of Data transfer mode of RS-232C
4	Interval of time out error of RS-232C 00 - 1 second 01 - 3 second 10 - 5 second 11 - 10 second		Transmission condition of RS-232C 0 - Weight stable 1 - Unconditional	Additional parity code in text of RS-232C 0 - No 1 - Yes
5	Tare Weight in text of RS-232C 0 - No 1 - Yes			
6 - 11				

16.5.2. Weight & Measure Spec List

SPEC NO.	BIT 3	BIT 2	BIT 1	BIT 0
12	Version display when power on 0 - Allow 1 - Inhibit	Selection of segment-check style 0 - Fast 1 - Standard	Decimal point figure for numeral 0 - Period (.) 1 - Comma (,)	
13	Price Base 00 - \$ / kg 01 - \$ / 100g 10 - \$ / lb 11 - \$ / 1/4lb		Start range 00 - ±10% F.S. 01 - ±5% F.S. 10 - ±3% F.S. 11 - ±2% F.S.	
14	Decimal point position on weight display 00 - No decimal point 01 - 2nd digit (0000.0) 10 - 3rd digit (000.00) 11 - 4th digit (00.000)		Decimal point position on unit and total price 00 - No decimal point for Unit & Total Price 01 - 2nd digit (0000.0) for Unit, 2nd digit (00000.0) for Total Price 10 - 3rd digit (000.00) for Unit, 3rd digit (0000.00) for Total Price 11 - 4th digit (00.000) for Unit, 4th digit (000.000) for Total Price	
15	Minimum display 00 - 1 01 - 2 10 - 5 11 - 10		Selection of resolution 00 - 1/3000 01 - 1/6000 10 - 1/7500 11 - Not used	
16	Weight single interval or multi-interval 0 - Single interval 1 - Multi-interval	Negative weight display mask 0 - Minus gross > 9e 1 - Minus gross Weight	Rounding for total price 00 - Rounding 01 - Truncation 10 - Cut up 11 - Not used	

SPEC NO.	BIT 3	BIT 2	BIT 1	BIT 0
17	Additional rounding for total price 000 - No additional rounding 001 - 1/4 rounding (25 step) 010 - Special rounding (5 step) 011 - 5 floor rounding (0-4 -> 0, 5-9 -> 5) 100 - Rounding for 1 st digit 101 - Truncate 1 st digit 110 - Cut up 1 st digit 111 - Not used			
18	Manual tare cancellation 0 - Allow 1 - Inhibit	Tare subtraction 0 - Allow 1 - Inhibit	Tare accumulation 0 - Allow 1 - Inhibit	Auto tare clear when rezero 0 - Allow 1 - Inhibit
19	Digital tare 0 - Allow 1 - Inhibit	Zero tracking when tare 0 - Allow 1 - Inhibit	Weight reset when tare 0 - Allow 1 - Inhibit	Tare auto clear 0 - Allow 1 - Inhibit
20	Unit price auto clear 0 - Allow 1 - Inhibit	Auto clear condition 0 - \geq Gross 21e & \geq Net 5e 1 - \geq Net 1e & price not 0	Weight stability condition 00 - Loose 01 - Normal 10 - Tight 11 - Stringent	
21	Re-zero function 0 - Allow 1 - Inhibit	Auto Zero function 0 - Allow (for Japan) 1 - Inhibit	Weight range of data output 0 - Always 1 - Over 20e	
22 - 31				

17. Operations In Weighing Mode

17.1. ON/OFF

1 - NET 2 - ZERO 3 - AUTO ZERO

OPERATION	WEIGHT	1	2	3	REMARKS
Power ON	V r X.X X 8 8 8.8.8.8 8 8 8.8.8.8 8 8 8 8 8				Display software version for 2 seconds. Display for 1 seconds. *Note1 Blank for 1 seconds. Display for 1 seconds. Blank for 1 seconds.
Ready to operate	0.0 0 0		▼		Weighing mode.
Power OFF					Power OFF.

* Note1: Power On Segment Check Style can be selected by setting SPEC12.2. In this example assume SPEC12.2 = 0.

17.2. Weight Reset

1 - NET 2 - ZERO 3 - AUTO ZERO

OPERATION	WEIGHT	1	2	3	REMARKS
Put 60g on the platter [RE-ZERO]	0.0 6 0 8 8 8.8.8.8 0.0 0 0				Weight reset.
Add 2kg on the platter [RE-ZERO]	2.0 0 0 8 8 8.8.8.8 2.0 0 0				
					Exceeds RE-ZERO range (2% F.S.).

17.3. Tare Subtraction

1 - NET 2 - ZERO 3 - AUTO ZERO

OPERATION	WEIGHT	1	2	3	REMARKS
	0.0 3 0				Put tare (e.g 30g) on platter.
[TARE]	0.0 0 0	▼			Subtract the tare weight.
Remove the tare weight	- 0.0 3 0	▼	▼		
[TARE]	0.0 0 0		▼		Clear the tare weight.

18. Error Message List

Following error message will appear when an incorrect operation is performed.

Message	Remarks	Appropriate Operation
O F	When displayed weight exceeded capacity+9d, or something is on the platter when power on.	Remove the item on the platter.
U F	When displayed minus weight >= 9d.	REZERO or ON/OFF again.
E r r o r	When calibration operation is not correct, when A/D fault, or when an error occurs in RS-232C communication.	Repeat calibration operation.
8 8 8 8 8	When scale is not steady when power on.	Place scale on firm, flat base.

19. RS-232C Interface

19.1. Specification

Baud Rate : 1200 / 2400 / 4800 / 9600 / 19200 BPS.
 Start Bit : 1 Bit.
 Stop Bit : 1 / 2 Bit.
 Date Bit : 7 / 8 Bits.
 Parity Bit : Even / Odd / None.

19.2. Pin Assignment

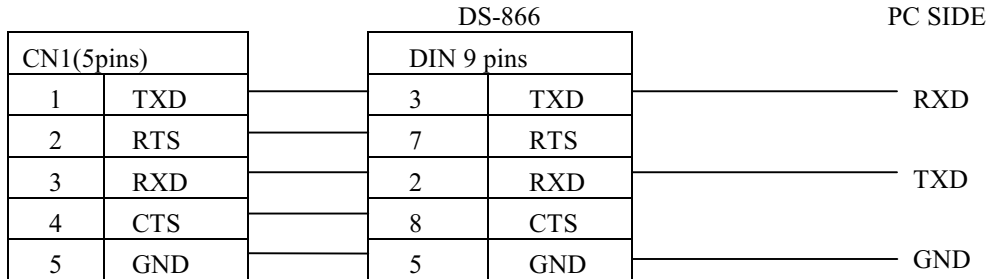

19.3. Control Code and Characters

Termination Code	CR	The end of data	0x0d
	LF	The end of Text	0x0a
Date	'0' ~ '9'	Numeric date	0x30 ~ 0x39
	'-' (Minus)	Minus sign	0x2d
	'.' (Decimal)	Decimal	0x2e
	' '(Space)	Data error or empty	0x20
	OF	Overflow	0x4f 0x46
	UF	Underflow	0x55 0x46
Header Code	'0'	Net Weight	0x30
	'4'	Tare Weight	0x34
	'U'	Unit Price	0x55
	'T'	Total Price	0x54
Command	ENQ	Enquiry	0x05
	ACK	Acknowledge	0x06
	NAK	Not Acknowledge	0x15

19.4. Standard type
19.4.1. Data Format

A) Without additional parity (Total 37 Bytes)

Status Flag	Weight Condition Flag	CR	Header Code	Net Weight	CR	Header Code	Tare Weight
1 Byte	1 Byte	1 Byte	1 Byte	6 Bytes	1 Byte	1 Byte	6 Bytes



CR	Header Code	Unit Price	CR	Header Code	Total Price	CR	LF
1 Byte	1 Byte	6 Bytes	1 Byte	1 Byte	7 Bytes	1 Byte	1 Byte

B) With additional parity (Total 38 Bytes)

Status Flag	Weight Condition Flag	CR	Header Code	Net Weight	CR	Header Code	Tare Weight
1 Byte	1 Byte	1 Byte	1 Byte	6 Bytes	1 Byte	Byte	6 Bytes



CR	Header Code	Unit Price	CR	Header Code	Total Price	CR	Additional Parity	LF
1 Byte	1 Byte	6 Bytes	1 Byte	1 Byte	7 Bytes	1 Byte	1 Byte	1 Byte

*Note: If the additional parity is 0x0d, 0x0a or 0x00, it will be changed to 0x1d, 0x1a or 0x10 respectively.

Status Flag:

Not Used	Fixed to 1	Not used	Price Base	Price Base	Total Price Overflow	Net	Additional Parity
----------	------------	----------	------------	------------	----------------------	-----	-------------------

Bit 7 : Not used. Always 0;

Bit 6 : Fixed to 1.

Bit 5 : Not used.

Bit 4 and Bit 3 : Price Base. 00 - \$/kg, 01 - \$/100g, 10 - \$/1b, 11 - \$/1/41b.

Bit 2 : Total Price Overflow. Set to 1 when total price overflow, 0 when not.

Bit 1 : Net. Set to 1 When tare subtraction is performed, 0 when not.

Bit 0 : Additional parity flag. Set to 1 when additional parity code is added in text, 0 when not.

Weight Condition Flag:

Not Used	Fixed to 1	Not used	Weight UF	Weight OF	Negative Net Weight	Weight Stable	Zero Sign
----------	------------	----------	-----------	-----------	---------------------	---------------	-----------

- Bit 7 : Not used. Always set 0.
- Bit 6 : Fixed to 1.
- Bit 5 : Not used.
- Bit 4 : Weight UF. Set to 1 when weight underflow, 0 when not.
- Bit 3 : Weight OF. Set to 1 when weight overflow, 0 when not.
- Bit 2 : Negative Net Weight. Set to 1 when net weight is negative, 0 when not.
- Bit 1 : Weight Stable. Set to 1 when weight is stable. 0 when not.
- Bit 0 : Zero Sign. Set to 1 when weight zero sign is set. 0 when not.

Example1: Transmit all data.

Net weight = 3.456 Tare weight = 1.200 Unit Price = 1.500 (\$/kg)
 Total Price = 5.184 Weight status : stable

Status Flag: 0x42

0	1	0	0	0	0	1	0
---	---	---	---	---	---	---	---

Weight Condition Flag: 0x42

0	1	0	0	0	0	1	0
---	---	---	---	---	---	---	---

By ASCII Code:

0x42	0x0d	0x30	0x30	0x33	0x2e	0x34	0x35	0x36	0x0d
------	------	------	------	------	------	------	------	------	------

0x34	0x30	0x31	0x2e	0x32	0x30	0x30	0x0d
------	------	------	------	------	------	------	------

0x55	0x30	0x31	0x2e	0x35	0x30	0x30	0x0d
------	------	------	------	------	------	------	------

0x54	0x30	0x30	0x35	0x2e	0x31	0x38	0x34	0x0d	0x0a
------	------	------	------	------	------	------	------	------	------

Example2: Only transmit Net weight and Total Price.

0x42	0x42	0x0d	0x30	0x30	0x33	0x2e	0x34	0x35	0x36	0x0d
------	------	------	------	------	------	------	------	------	------	------

0x54	0x30	0x30	0x35	0x2e	0x31	0x38	0x34	0x0d	0x0a
------	------	------	------	------	------	------	------	------	------

Example3: When weight is overflow, the following data is output.

0x42	0x48	0x0d	0x30	0x20	0x20	0x20	0x20	0x4f	0x46	0x0d
------	------	------	------	------	------	------	------	------	------	------

0x34	0x30	0x31	0x2e	0x32	0x30	0x30	0x0d
------	------	------	------	------	------	------	------

0x55	0x30	0x31	0x2e	0x35	0x30	0x30	0x0d
------	------	------	------	------	------	------	------

0x54	0x20	0x20	0x20	0x20	0x20	0x20	0x20	0x0d	0x0a
------	------	------	------	------	------	------	------	------	------

19.4.2. Communication Method

The data communication method can be selected from Stream(continuous), Manual, and Command by specification settings.

19.4.2.1. Standard stream type(Continuous Output)

Data is transmitted to PC side continuously.

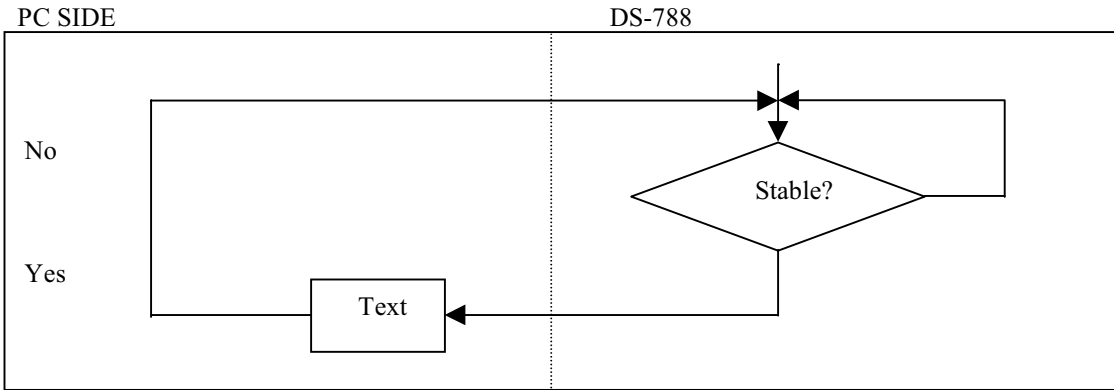

Note: Weight stable check depends on SPEC setting.

19.4.2.2. Standard command type

The data transmission starts by receiving the command from external (Ex. PC side).

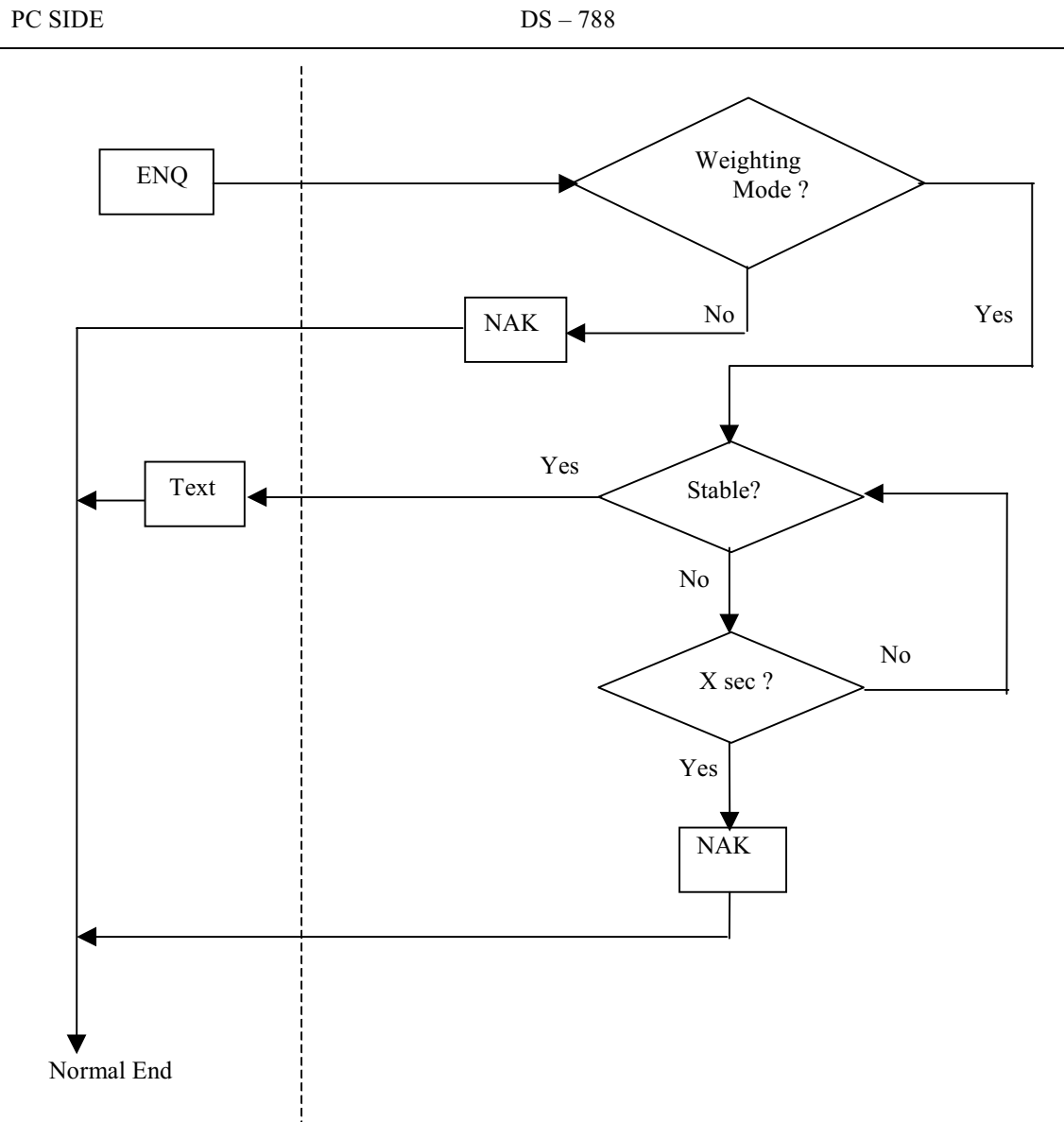

*Note: Weight stable check depends on SPEC setting.

19.5. QUQA TRADING type

ECR Request:

- 'DC1' : Output the data in transmission format 1.
- 'DC2' : Output the data in transmission format 2.

Data Strings Format:

Format1:

SOH	STX	STA	SIGN	W5	W4	W3	W2	W1	W0	UN1	UN2	BCC	ETX	EOT
-----	-----	-----	------	----	----	----	----	----	----	-----	-----	-----	-----	-----

Format2:

SOH	STX	P7	P6	P5	P4	P3	P2	P1	P0	BCC	ETX
-----	-----	----	----	----	----	----	----	----	----	-----	-----

STX	STA	SIGN	W5	W4	W3	W2	W1	W0	UN1	UN2	BCC	ETX
-----	-----	------	----	----	----	----	----	----	-----	-----	-----	-----

STX	U7	U6	U5	U4	U3	U2	U1	U0	BCC	ETX	EOT
-----	----	----	----	----	----	----	----	----	-----	-----	-----

STA : 'S'(0x53) when stable, 'U'(0x55) when unstable.

SIGN : ' '(0x20) when positive and zero, '-'(0x2d) when negative.

UN1 : ' '(0x20) when g, 'k'(0x6b) when kg, 'l'(0x6c) when lb.

UN2 : 'g'(0x67) when g, 'g'(0x67) when kg, 'b'(0x62) when lb.

BCC : Data block exclusive value.

W5 – W0 : Weight data with decimal point '.'(0x2e), when under flow or overflow all 'F'(0x46).

P7 – P0 : Total price data with decimal point '.'(0x2e), when overflow all 'F'(0x46).

U7 – U0 : Unit price data with decimal point '.'(0x2e).

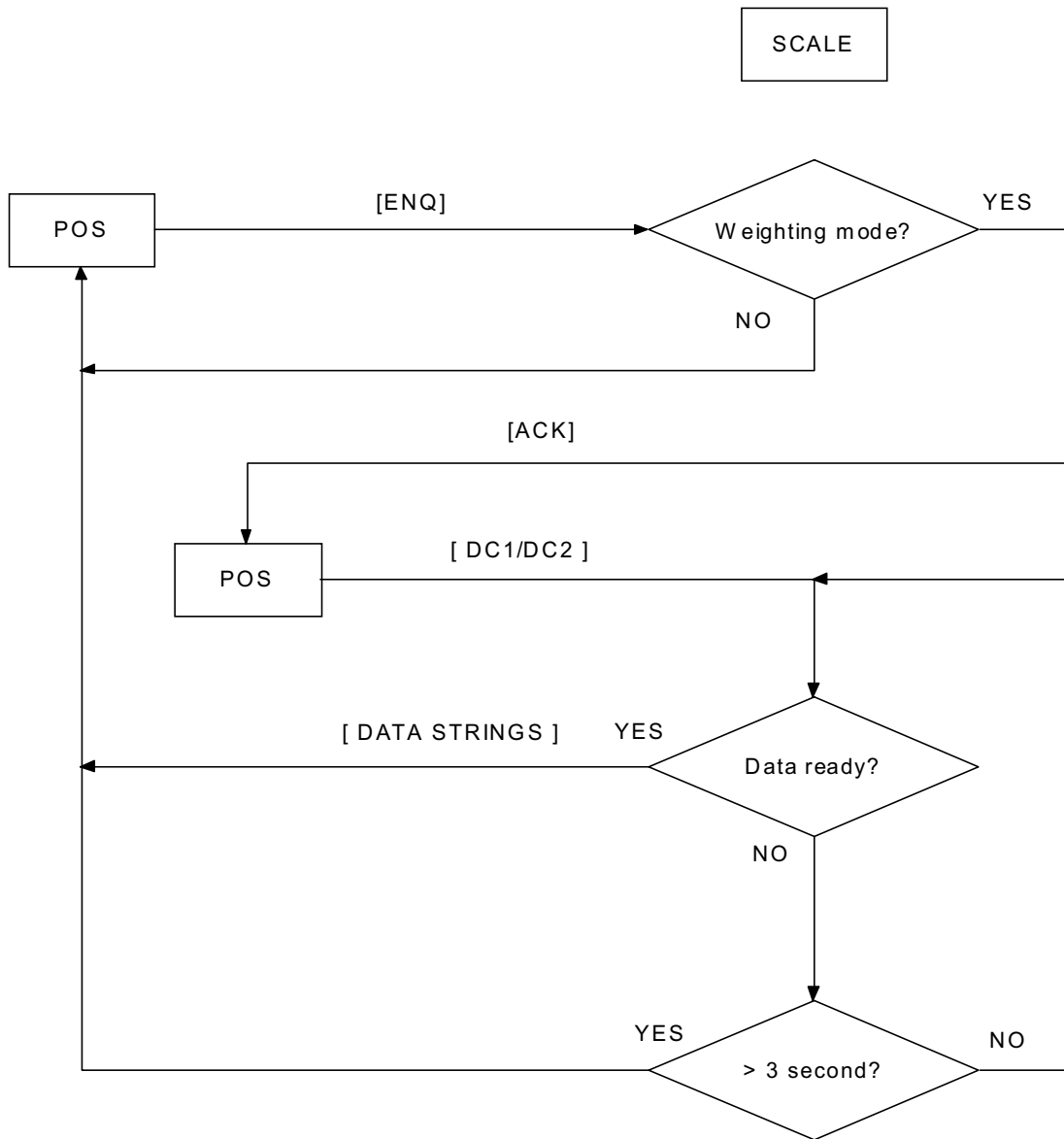

19.6. IBM, HUGIN type

Data Strings Format:

W5	W4	W3	W2	W1	RS
----	----	----	----	----	----

W5 ~ W1 : Weight data (transmitted with ASCII code).

W5 : Tens of lbs or kgs.

W4 : Units of lbs or kgs.

W3 : Tenth of lbs or kgs.

W2 : Hundredth of lbs or kgs.

W1 : Thousandths of lbs or kgs.

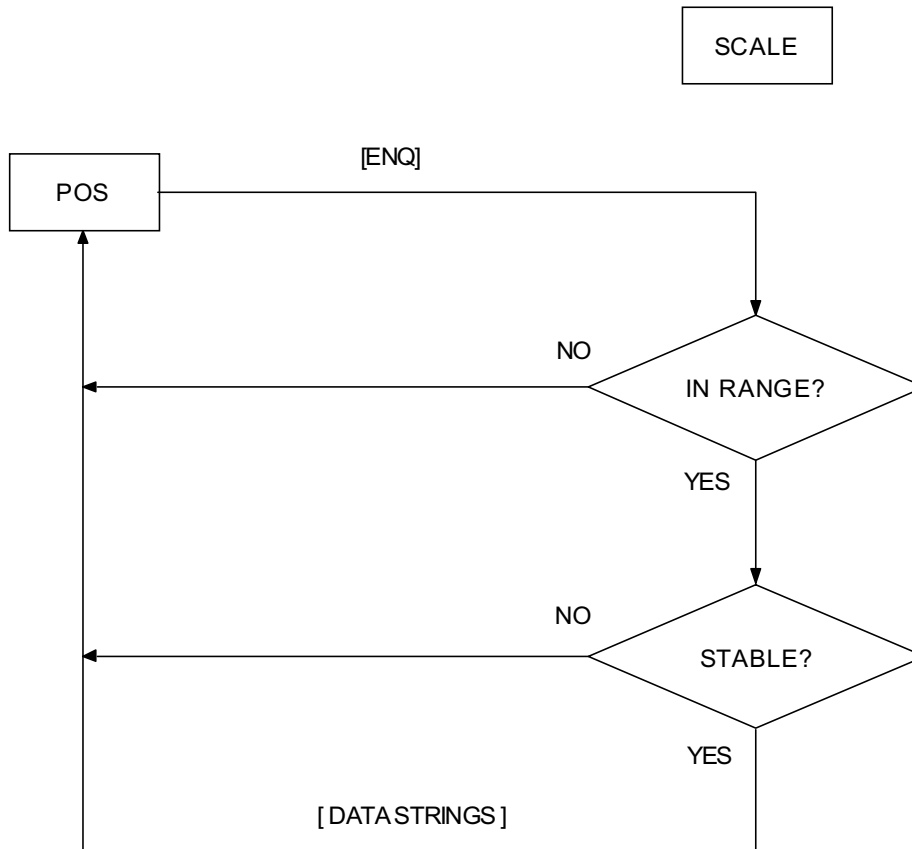

19.7. ICL type

Data Strings Format:

STX	ID	W5	W4	W3	W2	W1	BCC	ETX
-----	----	----	----	----	----	----	-----	-----

ID [Identification Bytes]

CODE THAT SHOWS CAPACITY OF SCALE AND MINIMUM DISPLAY.

CAPACITY	MINIMUM DISPLAY	FIGURE OF EACH BIT OF ID
		6543210
15kg	5g	11?1001
30LB	0.01LB	11?1010

Note: BIT 4 is always 0 for ACTUAL(OMRON) AND PORTUGAL.

In OLD (OMRON), BIT4 becomes 1 unless weight data exceeds the digits of display or if it does not exceed PRINTING OUT OF RANGE.

In this case, weight data is transmitted all with '0'(0x30).

W5 ~ W1 : Weight data (transmitted with ASCII code).

W5 : Tens of lbs or kgs.

W4 : Units of lbs or kgs.

W3 : Tenth of lbs or kgs.

W2 : Hundredth of lbs or kgs.

W1 : Thousandths of lbs or kgs.

Even if the highest digit is 0, it is transmitted as '0'(0x30).

BCC [Block Check Character] : Exclusive OR value of all data except STX and ETX.

19.7.1. ICL (OLD, OLD OMRON) type

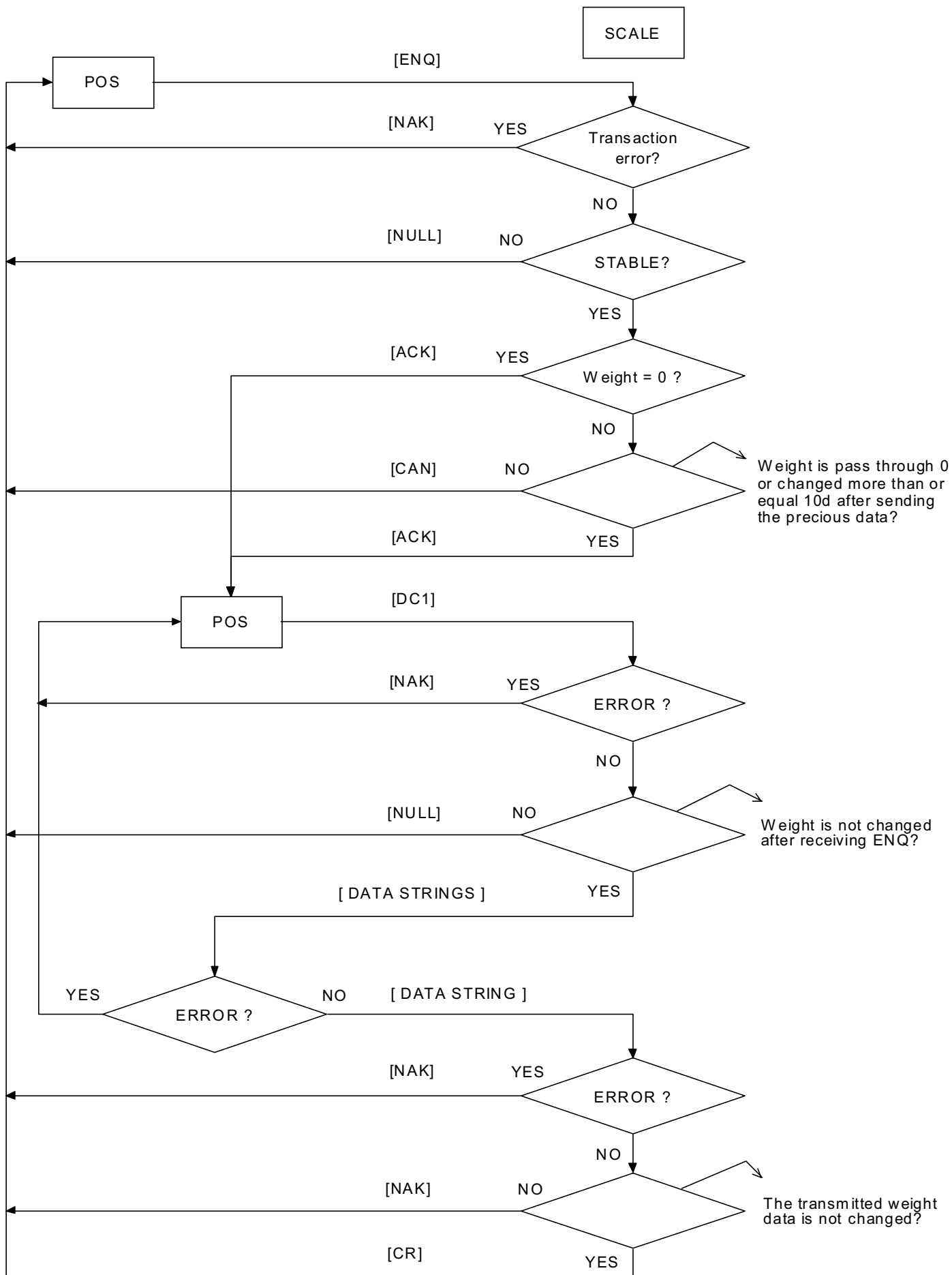

19.7.2. ICL (PORTUGAL) type

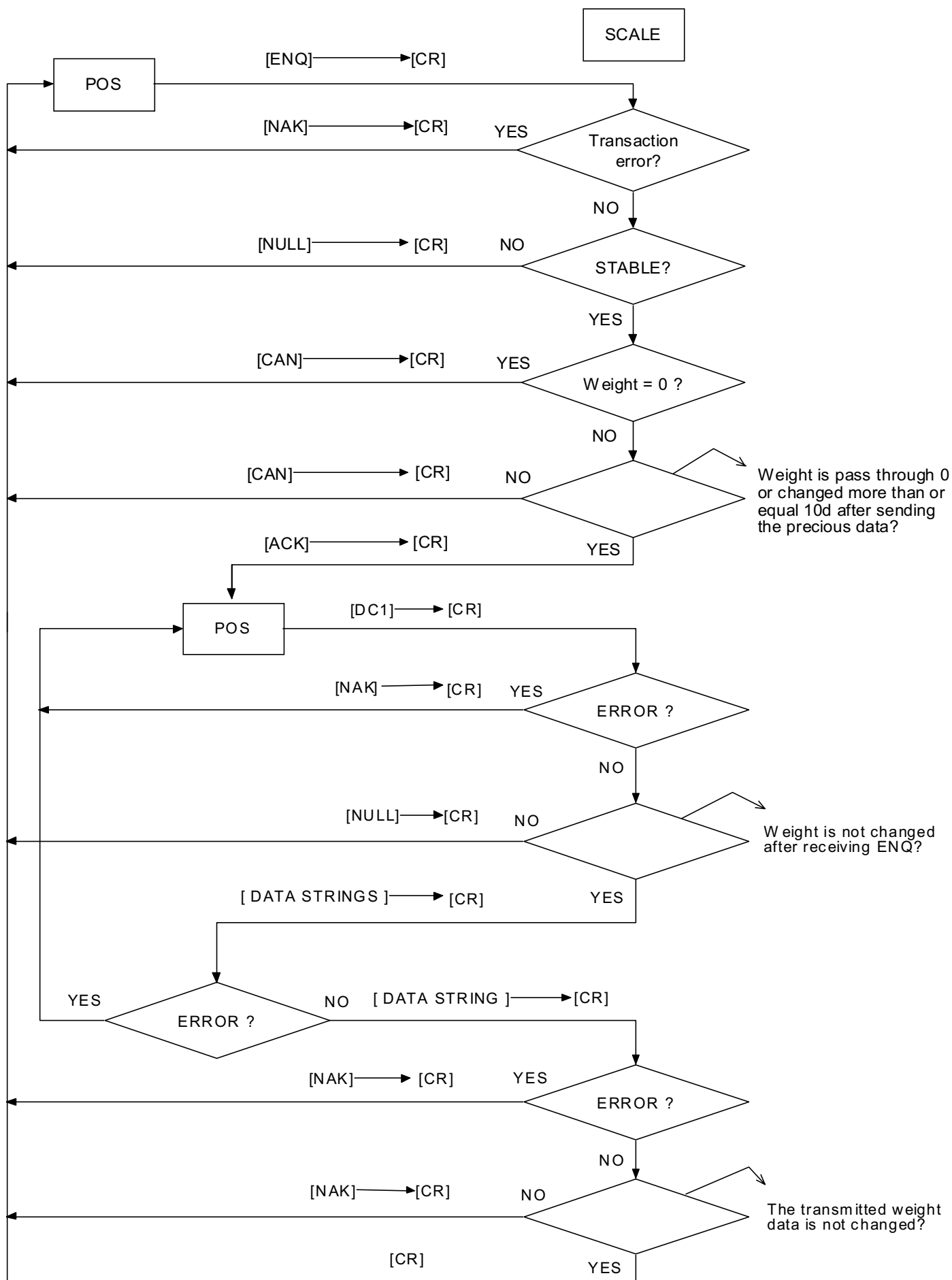

19.7.3. ICL (ACTUAL, ACTUAL OMRON) type

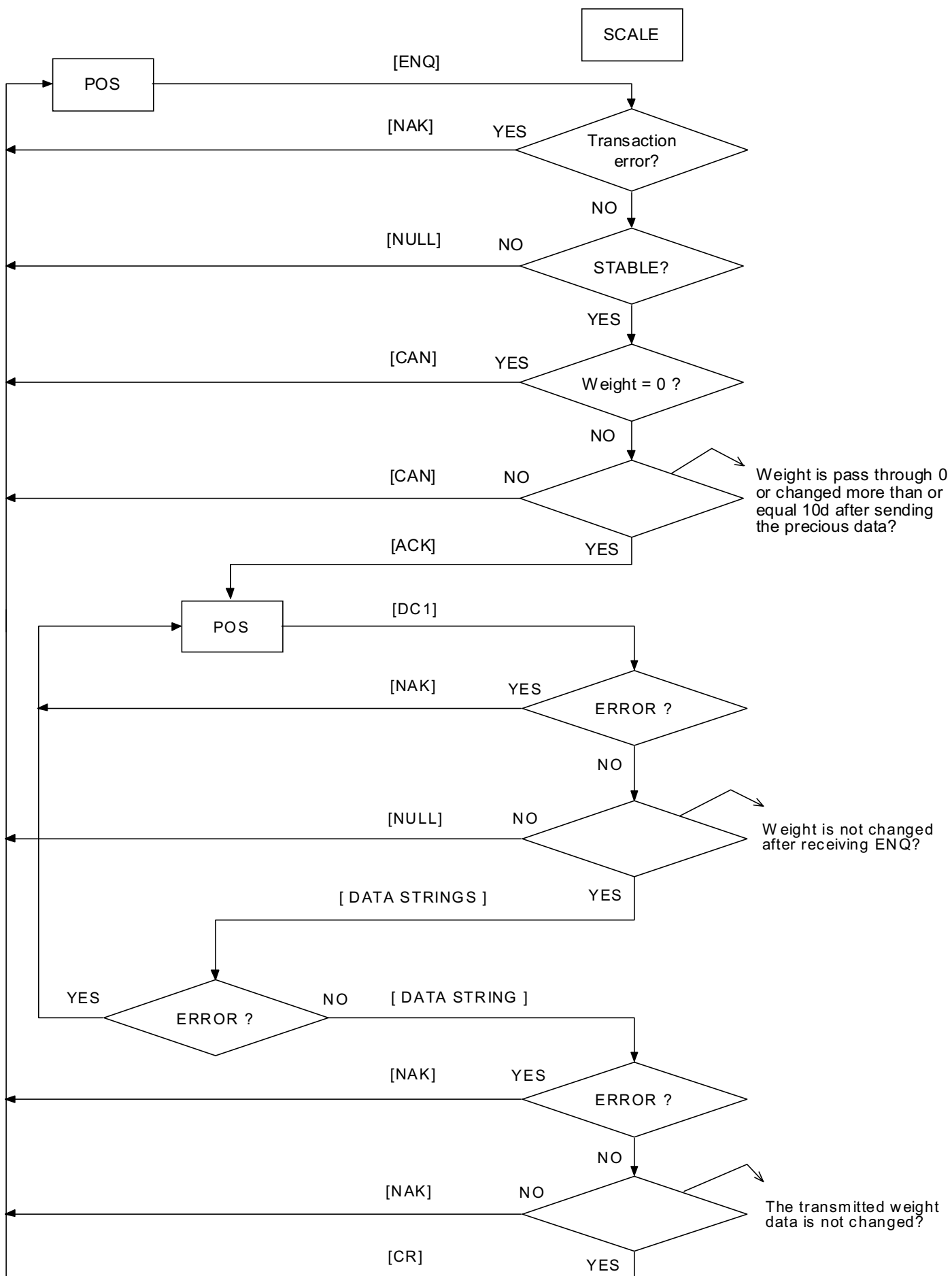

19.8. CAS interface type

ECR Request:

'DC1' : Output the data in transmission format 1.

'DC2' : Output the data in transmission format 2.

Data Strings Format:

Format1:

SOH	STX	STA	SIGN	W4	W3	DP	W2	W1	W0	k	g	BCC	ETX	EOT
-----	-----	-----	------	----	----	----	----	----	----	---	---	-----	-----	-----

Format2:

SOH	STX	P6	P5	P4	P3	P2	DP	P1	P0	BCC	ETX
-----	-----	----	----	----	----	----	----	----	----	-----	-----

STX	STA	SIGN	W4	W3	DP	W2	W1	W0	k	g	BCC	ETX
-----	-----	------	----	----	----	----	----	----	---	---	-----	-----

STX	U6	U5	U4	U3	U2	DP	U1	U0	BCC	ETX	EOT
-----	----	----	----	----	----	----	----	----	-----	-----	-----

STA : 'S'(0x53) when weight is stable, 'U'(0x55) when weight is unstable.

SIGN : ' '(0x20) when zero or positive weight, '-'(0x2d) when negative, 'F'(0x46) when overflow.

DP : '.'(0x2e) decimal point.

k : 'k'(0x6b).

g : 'g'(0x67).

W4 ~ W0 : Weight data.

P6 ~ P0 : Price data.

U6 ~ U0 : Unit Price data.

BCC : Created by XOR (exclusive or) of data block.

SAMPLES:

1. Plate empty, no UNIT PRICE, no PRICE:

a) after DC1

SOH	STX	<u>STA</u>	<u>SIGN</u>	W4	W3	<u>KD</u>	W2	W1	W0	k	g	BCC	ETX	EOT
01	02	53	20	20	30	2e	30	30	30	6b	67	71	03	04

b) after DC2

SOH	STX	P6	P5	P4	P3	P2	<u>KD</u>	P1	P0	BCC	ETX	STX	<u>STA</u>	<u>SIGN</u>	W4	W3	<u>KD</u>	
01	02	20	20	20	20	30	2e	30	30	1e	03	02	53	20	20	30	2e	
W2	W1	W0	k	g	BCC	ETX	STX	U6	U5	U4	U3	U2	<u>KD</u>	U1	U0	BCC	ETX	EOT
30	30	30	6b	67	71	03	02	20	20	20	20	30	2e	30	30	1e	03	04

2) 380g on plate , no UNIT PRICE, no PRICE:

a) after DC1

SOH	STX	<u>STA</u>	<u>SIGN</u>	W4	W3	<u>KD</u>	W2	W1	W0	k	g	BCC	ETX	EOT
01	02	53	2d	20	30	2e	33	38	30	6b	67	7a	03	04

b) after DC2

SOH	STX	P6	P5	P4	P3	P2	<u>KD</u>	P1	P0	BCC	ETX	STX	<u>STA</u>	<u>SIGN</u>	W4	W3	<u>KD</u>	
01	02	20	20	20	20	30	2e	30	30	1e	03	02	53	20	20	30	2e	
W2	W1	W0	k	g	BCC	ETX	STX	U6	U5	U4	U3	U2	<u>KD</u>	U1	U0	BCC	ETX	EOT
33	38	30	6b	67	7a	03	02	20	20	20	20	30	2e	30	30	1e	03	04

3) 1000g on plate, UNIT PRICE is 1.00 , PRICE is 1.00 :

a) after DC1

SOH	STX	<u>STA</u>	<u>SIGN</u>	W4	W3	<u>KD</u>	W2	W1	W0	k	g	BCC	ETX	EOT
01	02	53	20	20	31	2e	30	30	30	6b	67	70	03	04

c) after DC2

SOH	STX	P6	P5	P4	P3	P2	<u>KD</u>	P1	P0	BCC	ETX	STX	<u>STA</u>	<u>SIGN</u>	W4	W3	<u>KD</u>	
01	02	20	20	20	20	31	2e	30	30	1f	03	02	53	20	20	30	2e	
W2	W1	W0	k	g	BCC	ETX	STX	U6	U5	U4	U3	U2	<u>KD</u>	U1	U0	BCC	ETX	EOT
30	30	30	6b	67	70	03	02	20	20	20	20	31	2e	30	30	1f	03	04

4) weight not stable, UNIT PRICE is 1.00 , PRICE is ????????:

a) after DC1

SOH	STX	<u>STA</u>	<u>SIGN</u>	W4	W3	<u>KD</u>	W2	W1	W0	k	g	BCC	ETX	EOT
01	02	55	20	20	31	2e	39	33	35	6b	67	79	03	04

b) after DC2

SOH	STX	P6	P5	P4	P3	P2	<u>KD</u>	P1	P0	BCC	ETX	STX	<u>STA</u>	<u>SIGN</u>	W4	W3	<u>KD</u>
01	02	20	20	20	20	31	2e	39	35	13	03	02	55	20	20	31	2e

W2	W1	W0	k	g	BCC	ETX	STX	U6	U5	U4	U3	U2	<u>KD</u>	U1	U0	BCC	ETX	EOT
39	34	35	6b	67	7e	03	02	20	20	20	20	31	2e	30	30	1f	03	04

5) -50g on plate, no UNIT PRICE, no PRICE:

a) after DC1

SOH	STX	<u>STA</u>	<u>SIGN</u>	W4	W3	<u>KD</u>	W2	W1	W0	k	g	BCC	ETX	EOT
01	02	53	2d	20	30	2e	30	35	30	6b	67	79	03	04

b) after DC2

SOH	STX	P6	P5	P4	P3	P2	<u>KD</u>	P1	P0	BCC	ETX	STX	<u>STA</u>	<u>SIGN</u>	W4	W3	<u>KD</u>
01	02	20	20	20	20	30	2e	30	30	1e	03	02	53	2d	20	30	2e

W2	W1	W0	k	g	BCC	ETX	STX	U6	U5	U4	U3	U2	<u>KD</u>	U1	U0	BCC	ETX	EOT
30	35	30	6b	67	79	03	02	20	20	20	20	30	2e	30	30	1e	03	04

6. 1540g on plate, UNIT PRICE is 9999.99 , no PRICE because of OVER LOAD:

a) after DC1

SOH	STX	<u>STA</u>	<u>SIGN</u>	W4	W3	<u>KD</u>	W2	W1	W0	k	g	BCC	ETX	EOT
01	02	53	20	20	31	2e	35	34	30	6b	67	71	03	04

b) after DC2

SOH	STX	P6	P5	P4	P3	P2	<u>KD</u>	P1	P0	BCC	ETX	STX	<u>STA</u>	<u>SIGN</u>	W4	W3	<u>KD</u>
01	02	20	20	20	20	30	2e	30	30	1e	03	02	53	20	20	31	2e

W2	W1	W0	k	g	BCC	ETX	STX	U6	U5	U4	U3	U2	<u>KD</u>	U1	U0	BCC	ETX	EOT
35	34	30	6b	67	71	03	02	20	39	39	39	39	2e	39	39	e	03	04

7. more than 15kg on plate, UNIT PRICE (999.99) and PRICE are not displayed:

a) after DC1

SOH	STX	<u>STA</u>	<u>SIGN</u>	W4	W3	<u>KD</u>	W2	W1	W0	k	g	BCC	ETX	EOT
01	02	55	46	46	46	46	46	46	46	6b	67	1f	03	04

b) after DC2

SOH	STX	P6	P5	P4	P3	P2	<u>KD</u>	P1	P0	BCC	ETX	STX	<u>STA</u>	<u>SIGN</u>	W4	W3	<u>KD</u>
01	02	46	46	46	46	46	46	46	46	00	03	02	55	46	46	46	46

W2	W1	W0	k	g	BCC	ETX	STX	U6	U5	U4	U3	U2	<u>KD</u>	U1	U0	BCC	ETX	EOT
46	46	46	6b	67	1f	03	02	20	20	39	39	39	2e	39	39	17	03	04

Note:1. Can't communication When the Price Base is \$/lb or \$/1/4lb.

2. Can't communication When the Decimal point position on weight display is 2nd digit.

3. The unit and total price round when the Decimal point position on unit and total price display is 4th digit.

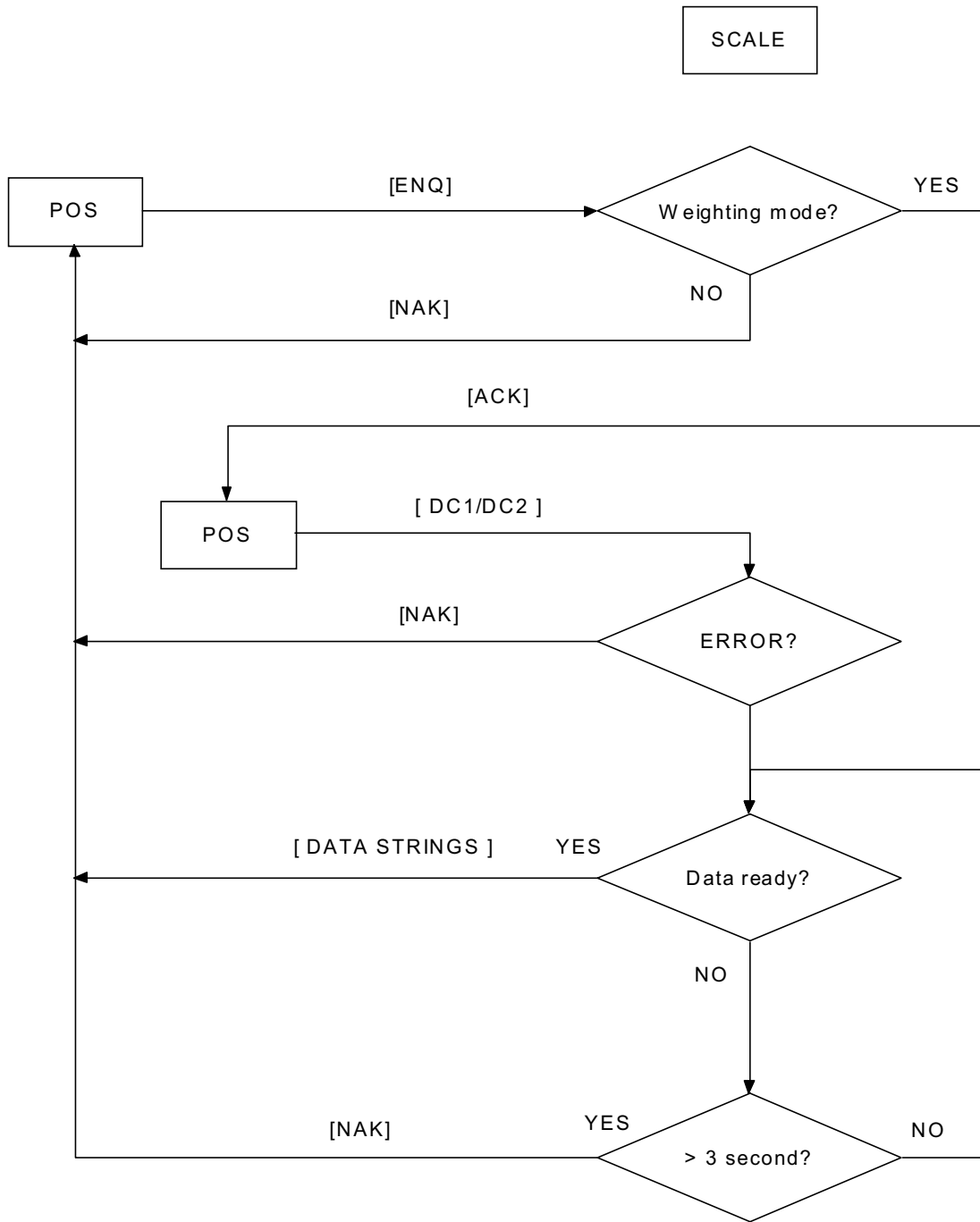

19.9. CAS (PORTUGAL) type

Data Strings Format:

STX	STA	SIGN	W5	W4	W3	W2	W1	W0	BCC
-----	-----	------	----	----	----	----	----	----	-----

STX : starting byte = 0x2

STA : weight status = "S" scale is stable
 "U" scale is unstable

SIGN : sign = " " if weight is zero or positive
 "- " if weight is negative
 "F" if over load

W5 – W0 : weight, fixed number or decimals = 3 decimals, 3 whole

BCC : control check = exclusive OR of all bytes

BCC = STX xor XTA xor SIGN xor W5 xor W4 xor W3 xor W2 xor W1 xor W0

Communication protocol

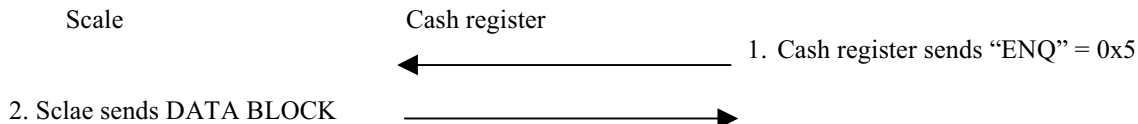

19.10. NIXDORF type

ECR Request:

STX	W	ETX
-----	---	-----

W : uppercase 'W'(0x57).

Data Strings Format:

STX	w	VVV,VVV	kg or lb	FFFFFFFFFFFF	BCC	ETX
-----	---	---------	----------	--------------	-----	-----

w : Lowercase 'w'(0x77).
VVV,VVV : Weight data (ASCII CODE) with Comma point ','(0x2c)
kg or lb : is switched according to the weight unit setting.
FFFFFFFFFFFF : twelve error flags.
If error flag stands, F on that area is set to '1'(0x31).
and all the other area is set to '0'(0x30).
BCC : Exclusive OR value of all data except STX and ETX.

Error flag description

1 : Stabilizing.
2 : Zero.
3 : Bellow zero.
4 : Tare active (not used).
5 : Under mini weight.
6 : Over weight range.
7 : PROM error (not used).
8 : Calibration error (not used).
9 ~ 12 : Reserved.

Note: The weight data rounds when Decimal point position on weight display is 2nd digit.

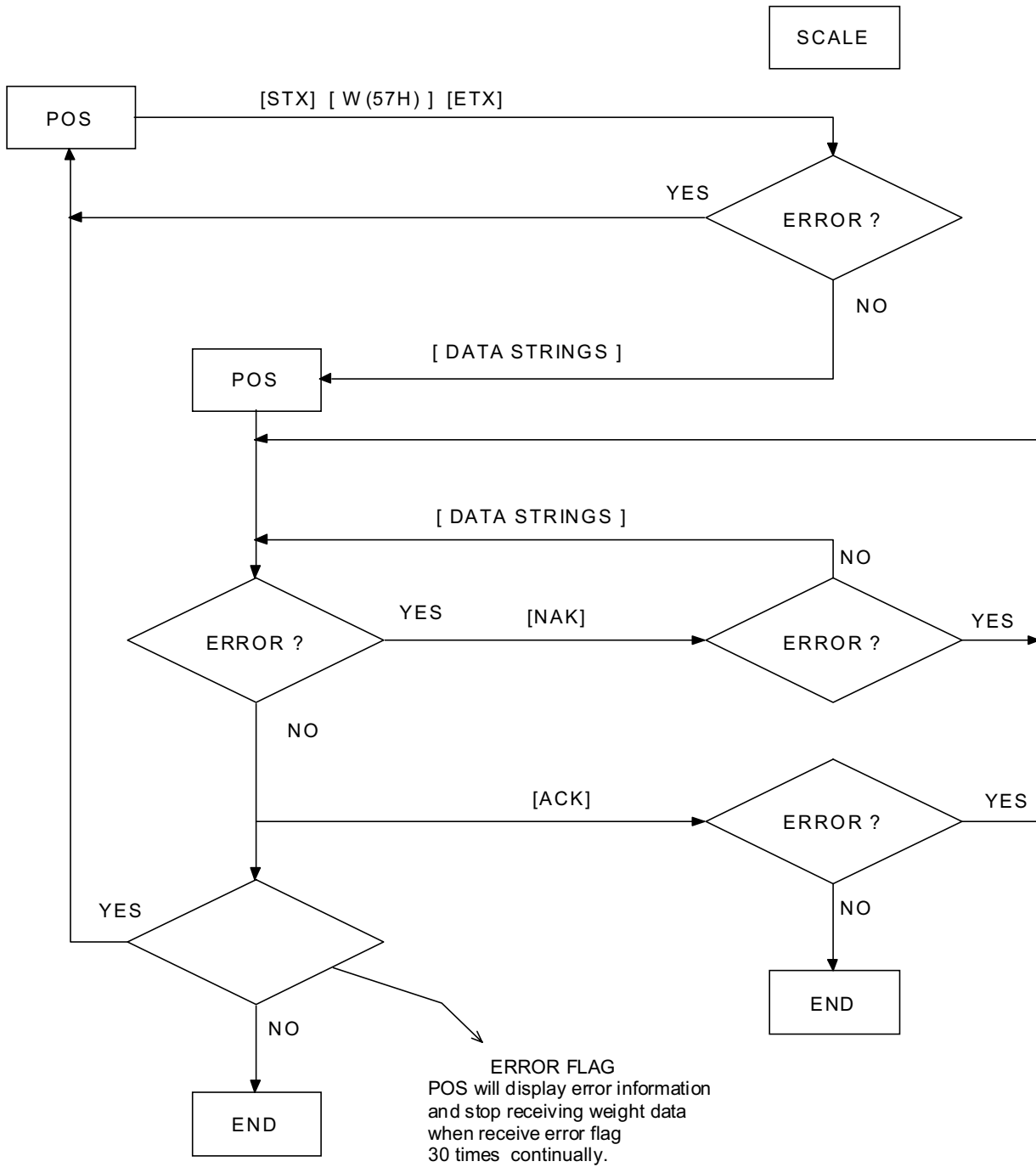

19.11. NCR type

ECR Request :

W	CR
---	----

W : Uppercase 'W'(0x57).

Data Strings Format:

LF	VVVVVV	KG or LB	CR	LF	S	Stat1	Stat2	CR	ETX
----	--------	----------	----	----	---	-------	-------	----	-----

VVVVVV : Weight data (ASCII code)

KG : 'K'(0x4b), 'G'(0x47).

LB : 'L'(0x4c), 'B'(0x42).

Stat1 and Stat2 : NOT USED FOR ERROR CODE (ALWAYS 00).

Note: The data string is not sent when net weight is less than 0.

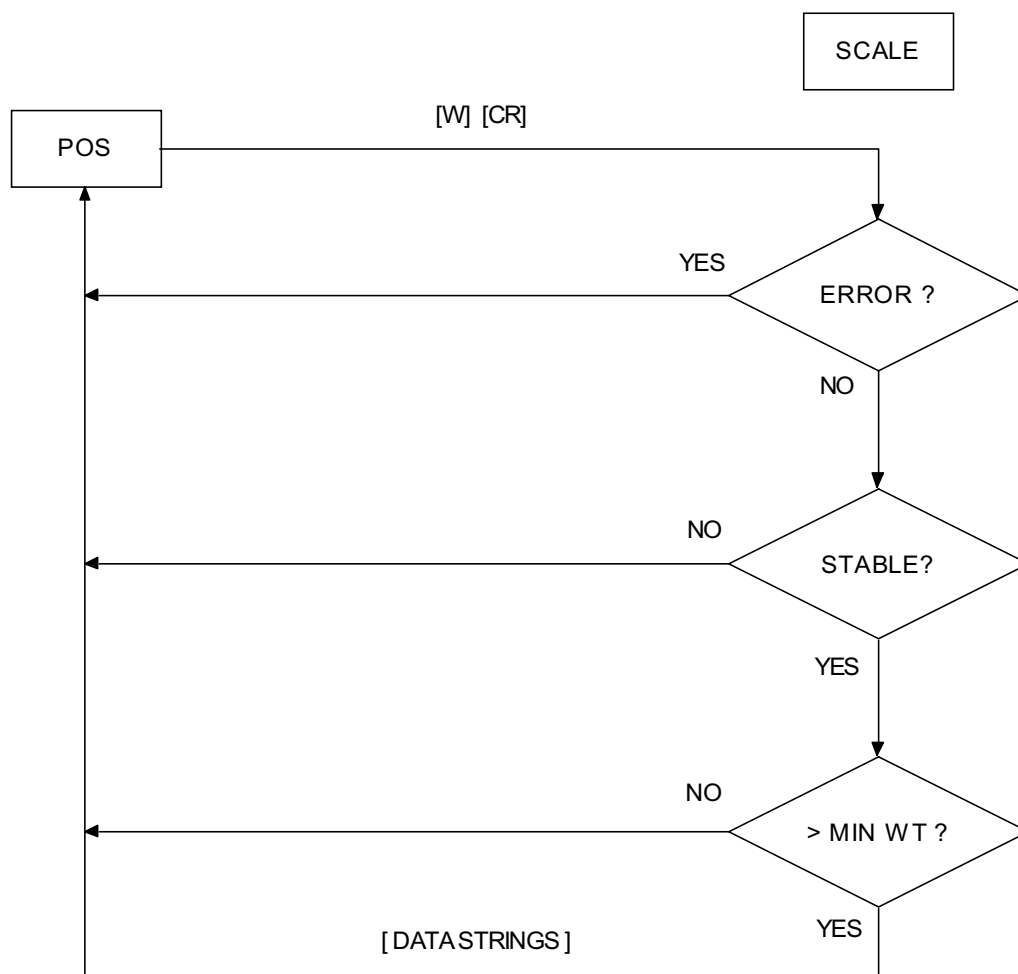

19.12. MONS type

ECR Request :

(ENQ → DC1)

ENQ : Check the scale status and await ACK return.

DC1 : Weight data request.

Data Strings Format:

SOH	STX	STATUS	SIGN	WW.WWW	UW1	UW2	BCC	ETX	EOT
-----	-----	--------	------	--------	-----	-----	-----	-----	-----

STATUS : 'S' (0x53).

SIGN : ' '(0x20).

UW1 : 'k'(0x6b).

UW2 : 'g'(0x67).

BCC : Not used (Fixed at 0).

WW.WWW : Weight data with decimal.

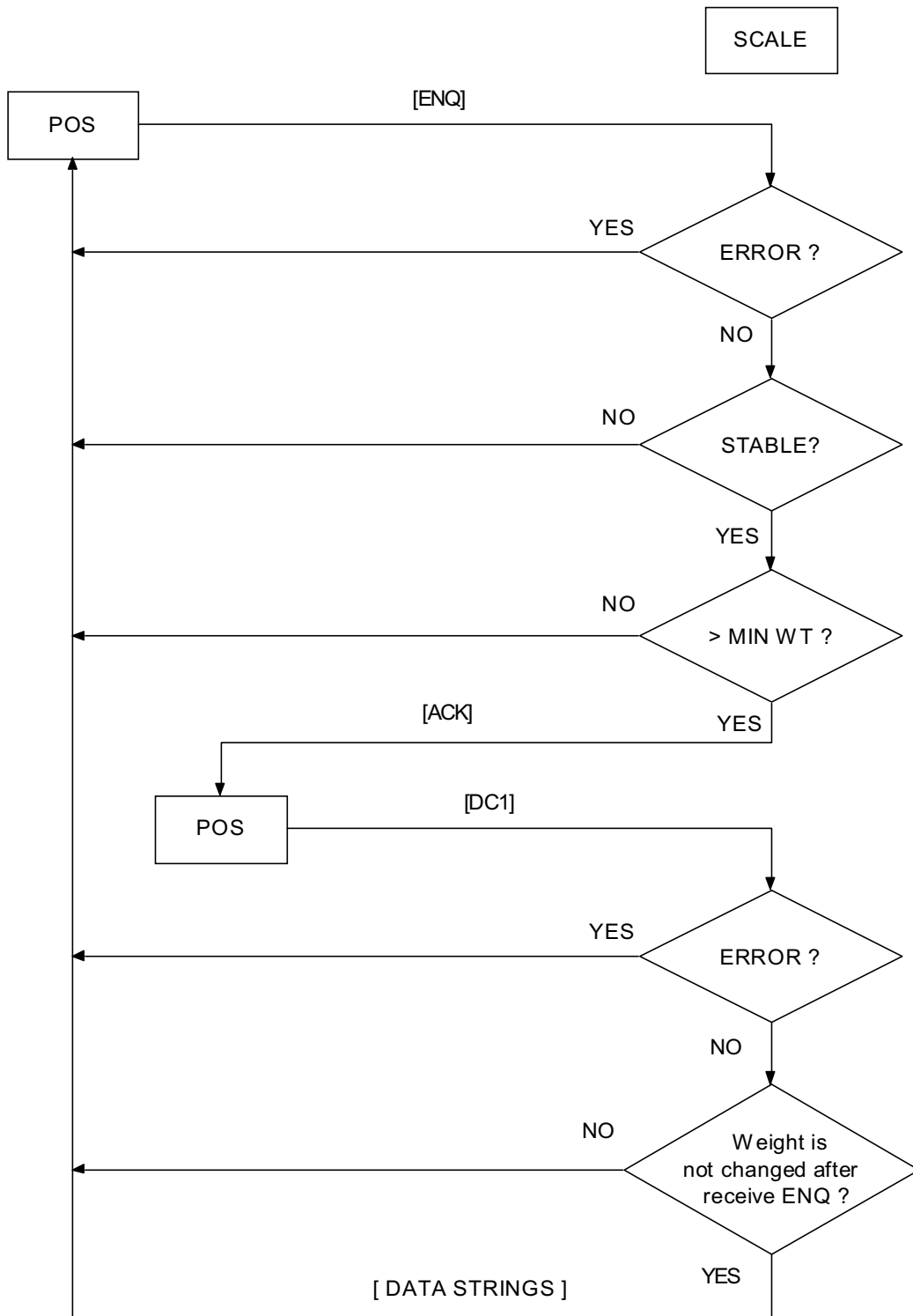

19.13. SHARP TK300, UP700 type

Data Strings Format:

-Record No. 01: transmission of unit price

EOT STX 0 1 ESC U5 U4 U3 U2 U1 U0 ESC ETX

-Record No. 03: transmission of unit price and tare value

EOT STX 0 3 ESC U5 U4 U3 U2 U1 U0 ESC T3 T2 T1 T0 ETX

-Record No. 04: transmission of unit price and text

EOT STX 0 4 ESC U5 U4 U3 U2 U1 U0 ESC A.....A ETX

-Record No. 05: transmission of unit price, tare value and text

EOT STX 0 5 ESC U5 U4 U3 U2 U1 U0 ESC T3 T2 T1 T0 ESC A.....A ETX

-Record No. 08: request for status information after receipt of NAK (response = record 09)

EOT STX 0 8 ETX

-ENQ: request for scale data (response = record 02)

EOT ENQ

-Record No. 02: valid weight value

STX 0 2 ESC X ESC W4 W3 W2 W1 W0 ESC U5 U4 U3 U2 U1 U0 ESC P5 P4 P3
P2 P1 P0 ETX

-Record No. 09: status information

STX 0 9 ESC S1 S0 ETX

-ACK: positive acknowledgement

-NAK: negative acknowledgement

- a) if scale has moved to error status
- b) if parity error has been detected on interface
- c) if incorrect record number has been detected
- d) if no valid unit price has been received
- e) if no valid tare value has been received
- f) if no valid text has been received
- g) if more than 50 characters have been received
- h) if scale has not yet stabilized
- i) if there was no movement since the last weighting operation
- j) if the scale is below the minimum load range
- k) if the scale is within the underload range
- l) if the scale is within the overload range

U5 ~ U0 : Unit price (5/6 digits)
T3 ~ T0 : Tare value (4 digits)
A . . . A : Text (13 digits)
W5 ~ W0 : Net weight (5 digits)
P5 ~ P0 : Total price (6 digits)
X (0x33) : Scale status (always kg)

S1 S0 (status)
0 0 : there is no error present
0 1 : general error on the scale
0 2 : parity error or more characters than permitted
1 0 : incorrect record number detected
1 1 : unit price invalid
1 2 : no valid tare value received
1 3 : no valid text received
2 0 : scale has not yet stabilized (no equilibrium)
2 1 : no movement since the last weighting operation
2 2 : price calculation not yet made
3 0 : scale within minimum load range
3 1 : scale shows underload or negative weight value display
3 2 : scale within overload range

*Note: SPEC13 must be set 00xx.
SPEC14 must be set 1110.

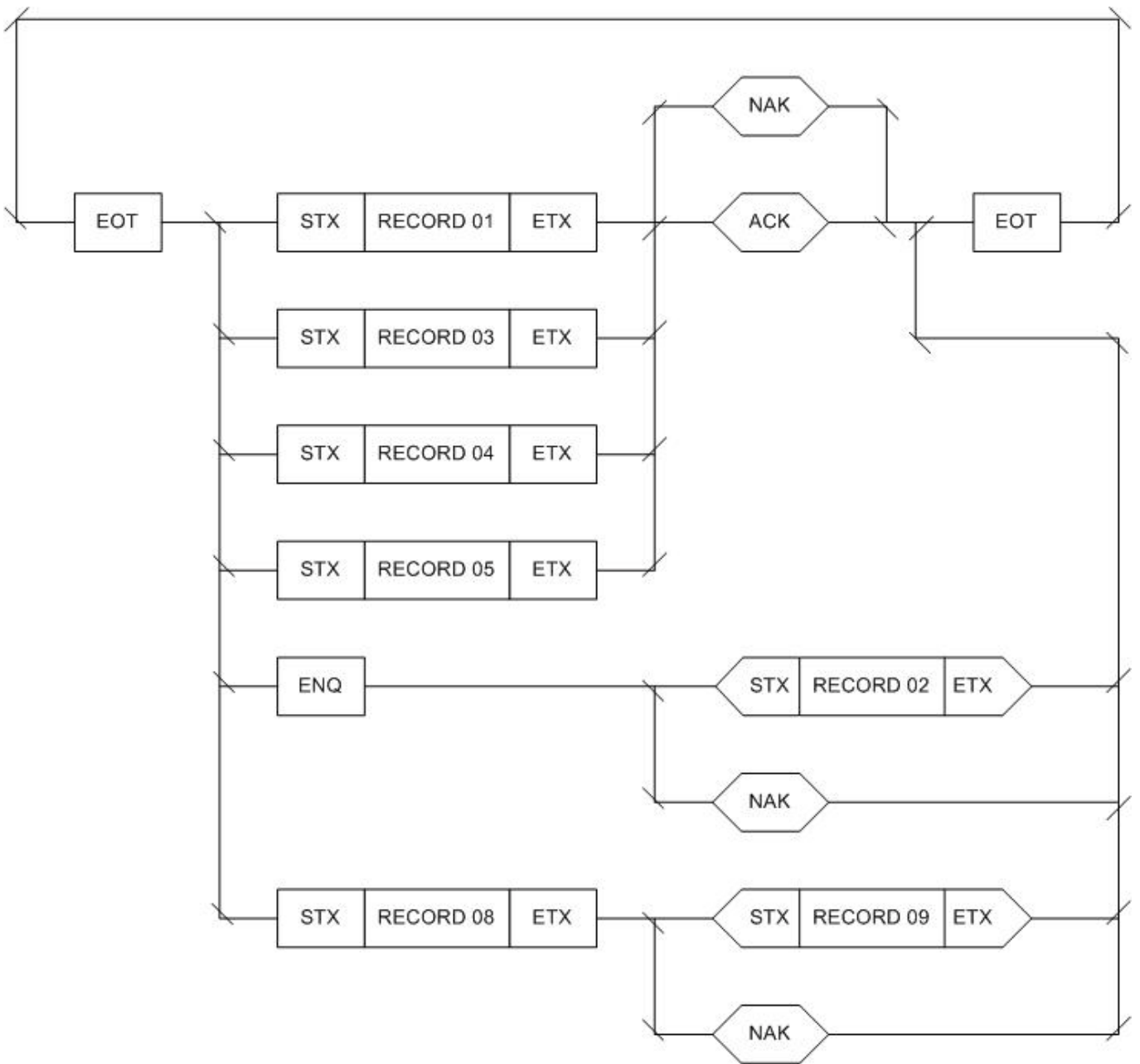

Cash register terminal



Scale

19.14. DATECS MP50/500 type

1. Command “TARE”

<0x00><0x00><0x01>

No reply from the scale. Command “TARE” to be executed.

2. Command “Enquiry with price”

<0x00><0x00><0x02><P1><P2><P3><P4><P5>

P1 to P5 designates price, starting from lowest figure. Junior tetrad for all bytes is all zeros. The scale displays the accepted pricing in “PRICE”, calculate the amount and reply with 17 bytes sequence.

<W1><W2><W3><W4><W5><W6><P1><P2><P3><P4><P5><T1><T2><T3><T4><T5><T6>

W1 to W6 designates weight starting from lowest figure. Senior tetrad for all bytes is all zeros.

P1 to P5 designates weight starting from lowest figure. Senior tetrad for all bytes is all zeros.

T1 to T6 designates weight starting from lowest figure. Senior tetrad for all bytes is all zeros.

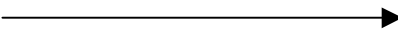
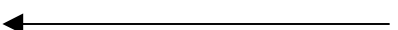
ECR SIDE		SCALE SIDE
1. ECR send “Enquiry” with price”	<0x00><0x00><0x02><PRICE1> 	
	<WEIGHT><PRICE2><TOTAL> 	2. If scale not stabilization without the answer. If scale stabilization do set the “PRICE1” to scale display, calculate the total sum and reply. Answer (17 bytes). PRICE1 = PRICE2

3. Command “Enquiry”

<0x00><0x00><0x03><0x00><0x00><0x00><0x00><0x00>

The scale reply is 17 bytes sequence

<W1><W2><W3><W4><W5><W6><P1><P2><P3><P4><P5><T1><T2><T3><T4><T5><T6>

W1 to W6 designates weight starting from lowest figure. Senior tetrad for all bytes is all zeros.

P1 to P5 designates weight starting from lowest figure. Senior tetrad for all bytes is all zeros.

T1 to T6 designates weight starting from lowest figure. Senior tetrad for all bytes is all zeros.

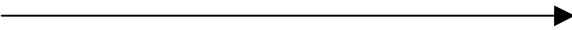
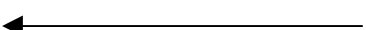
ECR SIDE		SCALE SIDE
1. ECR send “Enquiry”	<0x00><0x00><0x03><0x00><0x00><0x00><0x00><0x00> 	
	<WEIGHT><PRICE><TOTAL> 	2. If scale not stabilization without the answer. If scale stabilization do answer (17 bytes)

WEIGHT:designates weight starting from lowest figure. Format: <W1><W2><W3><W4><W5><W6>

Samples: Display 15.346 kg <0x36><0x34><0x33><0x35><0x31><0x30>(6 BYTE)

PRICE: designates price starting from lowest figure. Format: <P1><P2><P3><P4><P5>

Samples: Display 643.91 <0x31><0x39><0x33><0x34><0x36> (5 BYTE)

TOTAL: designates total sum starting from lowest figure. Format: <T1><T2><T3><T4><T5><T6>

Samples: Display 9374.56 <0x36><0x35><0x34><0x37><0x33><0x39>(6 BYTE)

***Note:** Reply to command 2,3 to be provided only if weight and scale stabilization.

19.15. NCI4000 type

Communication's protocol

<i>REGISTRATION MACHINE</i>	<i>DIRECTION</i>	<i>SCALE</i>	<i>OBSERVATION</i>
W<CR>	→ ←	<LF>xx.xxxKG<CR> <LF>Smn<CR><ETX>	x=net weight digits mn of state bytes
S<CR>	→ ←	<LF>Smn<CR><ETX>	mn of state bytes
Z<CR>	→ ←	<LF>Smn<CR><ETX>	Places the scale in zero and sends the state, mn of state bytes
Other sequences	→ ←	<LF>7<CR><ETX>	Command not recognized

*Note: When in calibration mode the scale will not send any command.

Interpretation of the bytes in state:

- m
 - Bite 0 = 1 unstable weight
 - Bite 0 = 0 stable weight
 - Bite 1 = 1 scale in zero
 - Bite 1 = 0 distinct weight in zero
 - Remaining bytes in 0.

- n
 - Bite 0 = 1 scale below zero
 - Bite 0 = 0 scale above zero
 - Bite 1 = 1 scale exceeding its maximum capacity
 - Bite 1 = 0 scale under its maximum capacity
 - Remaining bytes in 0.